



SPECIFICATIONS

- RATING :** 2A/36VDC
 - ELECTRICAL LIFE :** 200,000 make-and-break cycles at full load
 - MECHANICAL LIFE :** 1,000,000 cycles
 - INSULATION RESISTANCE :** 1,000 MΩ min. at 500VDC
 - DIELECTRIC STRENGTH :** 2,000V RMS @ sea level
 - CONTACT RESISTANCE :** 50 mΩ max.
 - OPERATION TEMPERATURE :** -20°C~+70°C
 - TRAVEL:** About 2.0±0.20mm
 - OPERATION PRESSURE :** 4.5N±1.5N
 - INGRESS PROTECTION :** IP67
 - TORQUE :** 11.5 kgf · cm
 - THICKNESS :** 8.0mm (Max.)
- Current limiting resistor is required to limit LED forward current to 20mA.**

MATERIALS

- BUSHING :** Aluminum alloy / Stainless Steel
- BASE :** PBT (UL 94-V0)
- ACTUATOR :** PC (Translucent UL 94-V2)
- CAP :** Aluminum alloy / Stainless Steel
- SPRING :** Steel.
- SEALING :** Silicone (Translucent).
- O-Ring :** Silicone (Translucent).
- TERMINAL :** Brass ,Gold flash plated.
- CONTACT :** Silver alloy.
- HEX NUT :** Brass (Nickel plated).



MPB16
Pushbutton Switches

IP 67
ACCORDING TO
EN 60529:1991+A1:2001
IEC 60529:2001



HOW TO ORDER

MODEL NO. BODY TYPE BUTTON TYPE LIGHT TYPE LED COLOR TERMINAL SHAPE TERMINAL PLATING LED VOLTAGE

MPB16 — [] — [] — [] — [] — [] — [R] — []

Body type: CA AL alloy (Natural Anodized), CB AL alloy (Black Anodized)

Button type: R Round, E Ring, P Power logo

Light type: E Ring, P Power logo

Terminal shape: J Solder terminal, T1 Wire length 500mm

Terminal plating: R Gold flash

LED color

ITEM NO	COLOR
0	Without LED
1	White
3	Red
4	Orange
5	Yellow
6	Green
7	Blue
DUAL COLOR LED	
A	Red&Green
RGB COLOR LED	
RGB	RGB

Accessories

Resistance (About LED Voltage)	
0V	Without Resistance
3V	LED input 3 VDC, 47Ω * Red/Yellow/Orange LED type only
6V	LED input 6 VD, 180ΩC
12V	LED input 12 VDC, 470Ω
24V	LED input 24 VDC, 1000Ω

* ohms value of resistance tolerance: ±5%

MODEL NO. BODY TYPE BUTTON AND LIGHT TYPE

MPB16 — [] — []

Body type: A1 Stainless (Natural), Double flat, A2 Stainless (Natural), A3 Stainless (Natural), D Shape

Button and light type: HE Ring, High, FP Power logo, Flat, FE Ring, Flat

EXAMPLE:
MPB16-CARE-0-JR-0 (Without LED)
MPB16-CARE- [] -JR- [] V
LED color LED voltage

MPB16 Series

16mm Metal Pushbutton Switches

CIRCUIT

※ According to the input voltage adjustment resistance

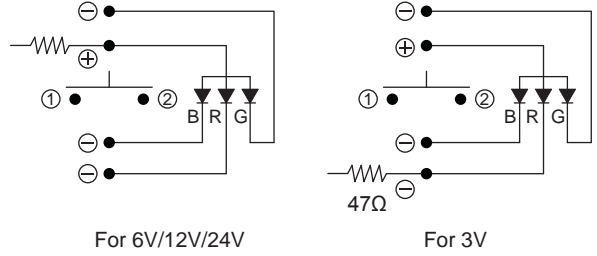
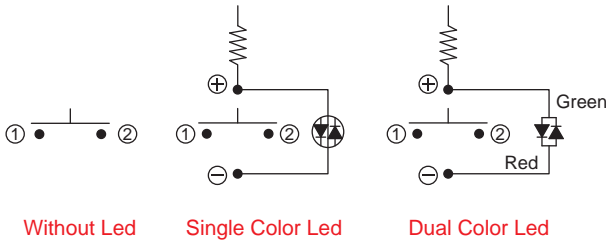

RGB Color Led

BODY TYPE

CA/CB Aluminum alloy

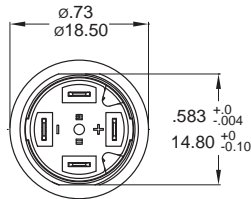
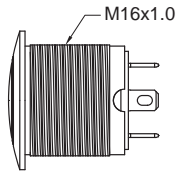

A1 Stainless Steel

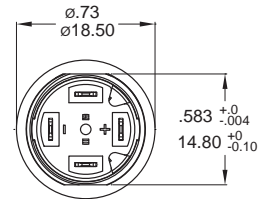
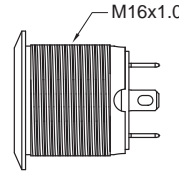

A2 Stainless Steel

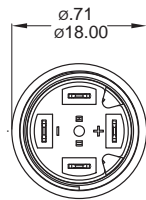
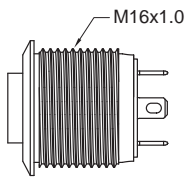

A3 Stainless Steel (D Shape)

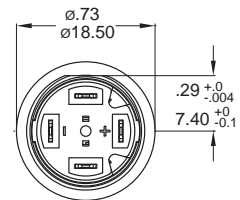
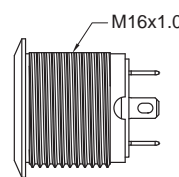

BUTTON TYPE

R Round Button

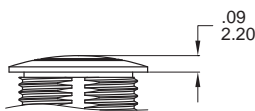

H High Button

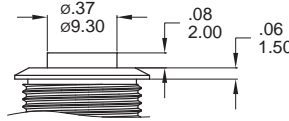

F Flat Button

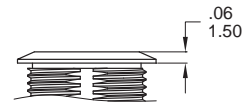

LIGHT TYPE

E Ring,Round

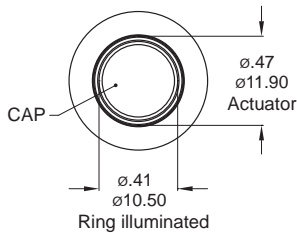

P Power logo,Round

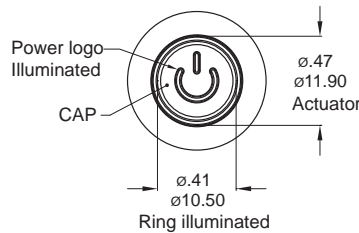

* E,P light type only for CA,CB body.

* HE,FE,FP light type only for A1,A2,A3 body.

HE Ring,High

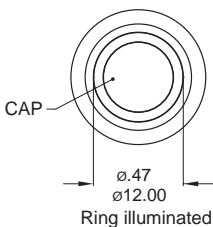

FE Ring,Flat

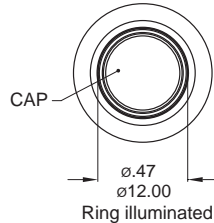

FP Power logo,Flat

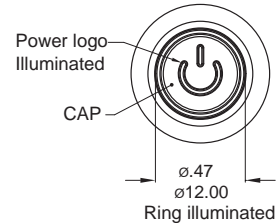

DIMENSION

E Ring

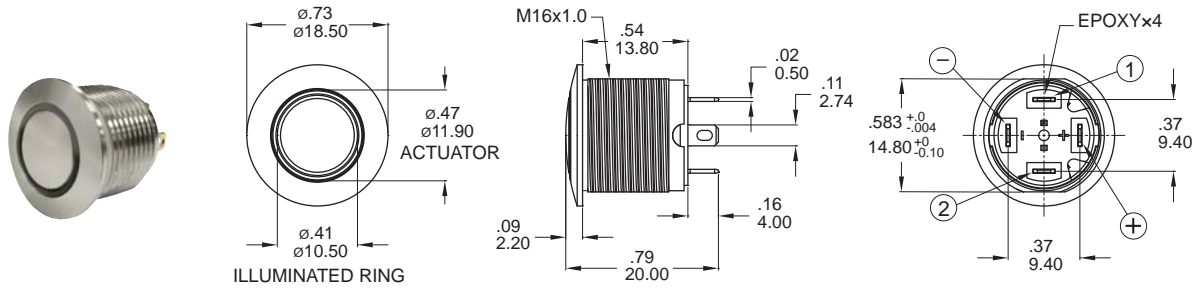

Part No. Shown : MPB16-CARE-□-JR-0V

P Power logo

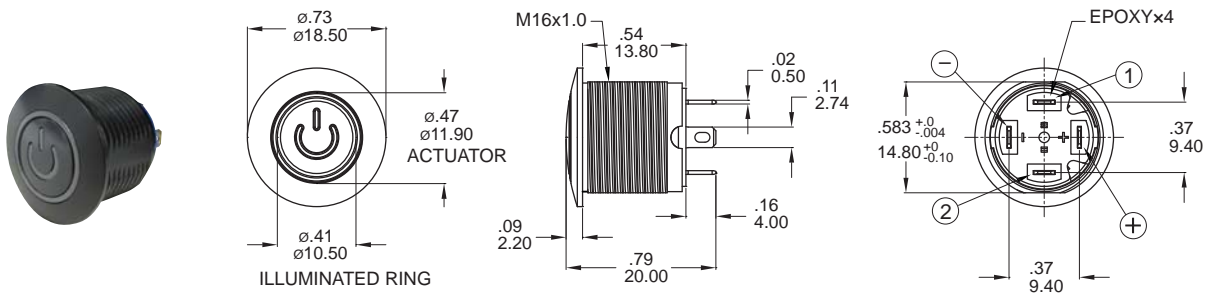

Part No. Shown : MPB16-CBRP-□-JR-0V

HE Ring

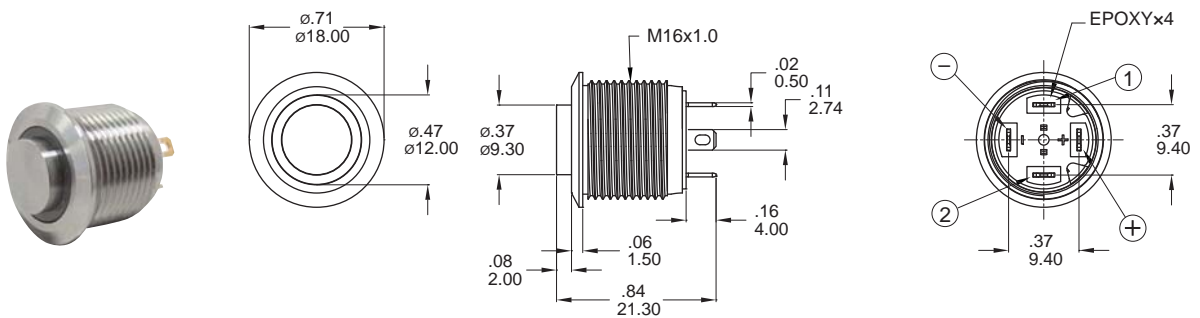

Part No. Shown : MPB16-A2HE-□-JR-0V

FP Power logo

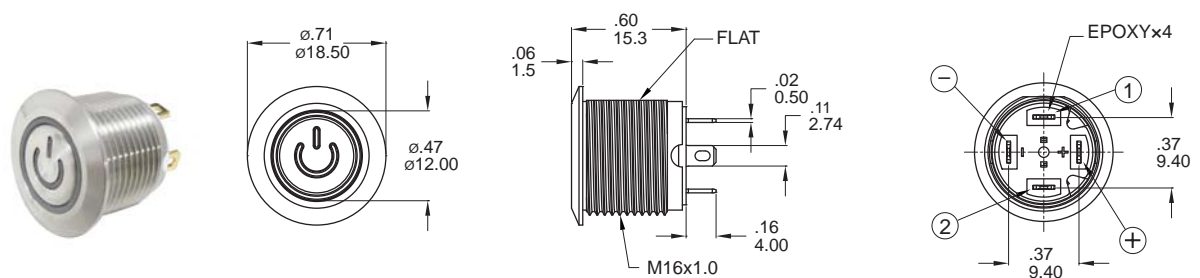

Part No. Shown : MPB16-A3FP-□-JR-0V



MPB16 Series

16mm Metal Pushbutton Switches

DIMENSION

E Ring

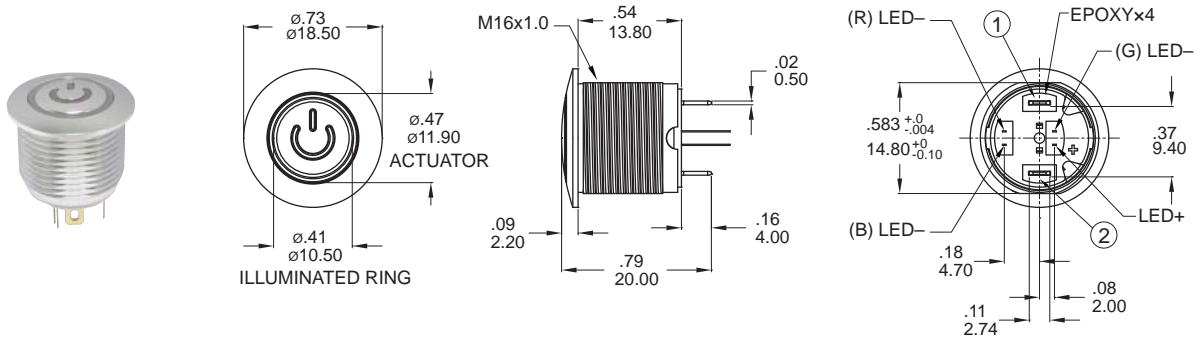

Part No. Shown : MPB16-CARE-RGB-JR-0V

PANEL CUTOUT / HARDWARE

PANEL CUTOUT

CA/CB/A1 Type

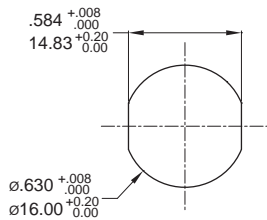

A3 Type

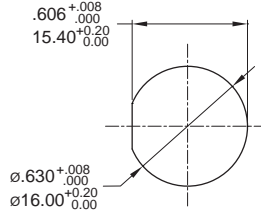

A2 Type

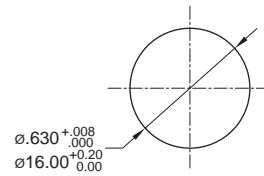

HARDWARE

O-RING

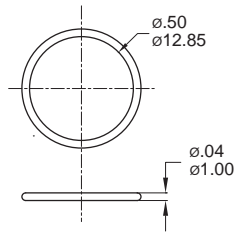

M16 NUT

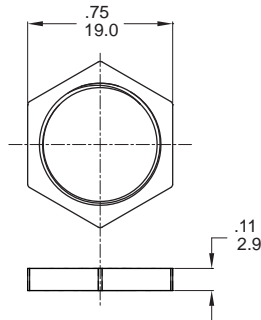

T1 ※Wire=Multi-wire lead AWG20,section 0.6mm²,UL approved

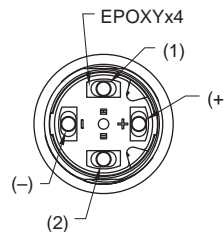
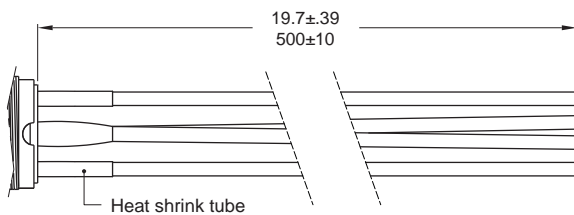

Non-LED

DESCRIPTION	WIRE COLOR
TERMINAL 1	BLACK
TERMINAL 2	BLACK

With LED

DESCRIPTION	WIRE COLOR
TERMINAL 1	BLACK
TERMINAL 2	BLACK
LED+	RED
LED-	GREEN

